



INSTRUCTION MANUAL

VHF TRANSCEIVER

IC-F521

UHF TRANSCEIVER

IC-F621

BIIS 1200
Compatible



Icom Inc.

IMPORTANT

READ ALL INSTRUCTIONS carefully and completely before using the transceiver.

SAVE THIS INSTRUCTION MANUAL— This instruction manual contains important operating instructions for the IC-F521 VHF TRANSCEIVER and IC-F621 UHF TRANSCEIVER.

EXPLICIT DEFINITIONS

WORD	DEFINITION
⚠ WARNING!	Personal injury, fire hazard or electric shock may occur.
CAUTION	Equipment damage may occur.
NOTE	Recommended for optimum use. No risk of personal injury, fire or electric shock.

Icom, Icom Inc. and the ICOM logo are registered trademarks of Icom Incorporated (Japan) in the United States, the United Kingdom, Germany, France, Spain, Russia and/or other countries.
SmarTrunk II™ is a trademark of SmarTrunk Systems, Inc.

PRECAUTION

⚠ WARNING! NEVER connect the transceiver to an AC outlet. This may pose a fire hazard or result in an electric shock.

NEVER connect the transceiver to a power source of more than 16 V DC such as a 24 V battery. This connection will damage the transceiver.

NEVER cut the DC power cable between the DC plug and fuse holder. If an incorrect connection is made after cutting, the transceiver might be damaged.

NEVER place the transceiver where normal operation of the vehicle may be hindered or where it could cause bodily injury.

NEVER allow children to touch the transceiver.

NEVER expose the transceiver to rain, snow or any liquids.

USE the supplied microphone only. Other microphones have different pin assignments and may damage the transceiver.

DO NOT use or place the transceiver in areas with temperatures below -22°F (-30°C) or above $+140^{\circ}\text{F}$ ($+60^{\circ}\text{C}$) or, in areas subject to direct sunlight, such as the dashboard.

AVOID operating the transceiver without running the vehicle's engine. The vehicle's battery will quickly run out if the transceiver is in transmission while the vehicle's engine OFF.

AVOID placing the transceiver in excessively dusty environments.

AVOID placing the transceiver against walls. This will obstruct heat dissipation.

AVOID the use of chemical agents such as benzine or alcohol when cleaning, as they damage the transceiver surfaces.

BE CAREFUL! The transceiver will become hot when operating continuously for long periods.

For U.S.A. only

CAUTION: Changes or modifications to this transceiver, not expressly approved by Icom Inc., could void your authority to operate this transceiver under FCC regulations.

TABLE OF CONTENTS

IMPORTANT	i
EXPLICIT DEFINITIONS	i
PRECAUTION	i
TABLE OF CONTENTS	ii
1 PANEL DESCRIPTION	1-7
■ Front panel	1
■ Function display	3
■ Programmable function keys	4
2 OPERATION	8-10
■ Turning power ON	8
■ Channel selection	8
■ Receiving and transmitting	9
3 BIIS OPERATION	11-22
■ Default setting	11
■ Receiving a call	11
■ Transmitting a call	13
■ Receiving a message	15
■ Transmitting a status	17
■ Transmitting an SDM	18
■ Position data transmission	20
■ Printer connection	20
■ PC connection	20
■ Digital ANI	20
■ Auto emergency transmission	21
■ Stun function	21
■ BIIS indication	21
■ Horn output	21
■ Priority A channel selection	22
4 SmarTrunk II™ OPERATION	23-24
■ SmarTrunk II™ and conventional modes	23
■ SmarTrunk II™ operation	23
5 CONNECTION AND INSTALLATION	25-30
■ Rear panel description and connection	25
■ Supplied accessories	26
■ Mounting the transceiver	27
■ Optional unit installation	28
■ Antenna	30
■ Fuse replacement	30
■ Cleaning	30
6 OPTIONS	31
7 SAFETY TRAINING INFORMATION	32

1

PANEL DESCRIPTION

■ Front panel

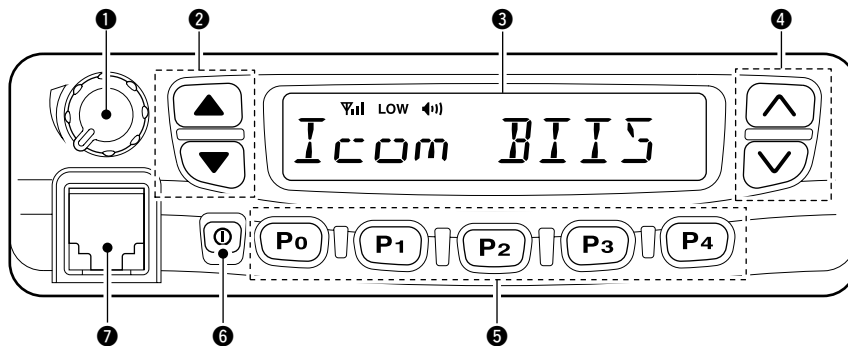

① AF VOLUME CONTROL KNOB

- Rotate the knob to adjust the audio output level.
- Minimum audio level is pre-programmed.

② STATUS UP/DOWN KEYS [▲]/[▼]

- ➔ During the standby condition, push to display the transmit status indication and select a status number.
- ➔ When a received SDM is displayed, push to cancel the automatic scroll and scroll the message manually.
- ➔ When an SDM that contains more than 10 characters is displayed, push to scroll the message manually.

③ FUNCTION DISPLAY (p. 3)

- Displays a variety of information such as an operating channel number/name, code, status message.

/// **NOTE:** The above functions depend on pre-programming.

④ CHANNEL UP/DOWN KEYS [^]/[v]

- ➔ During standby condition, push to select an operating channel.
- ➔ After pushing [TX CODE CH], push to select a TX code channel.
- ➔ After pushing [DTMF], push to select a DTMF channel.
- ➔ After pushing [SCAN], push to select a scan group.
- ➔ After pushing [DIGITAL], push to select a BIIS code, status number or SDM.

5 DEALER-PROGRAMMABLE KEYS [P0] to [P4]

Desired functions can be programmed independently by your Dealer. However, the following functions are assigned as the default for BIIS operation.

[P0] : [CALL]

Push to transmit a 5-tone/BIIS call.

- Call transmission is necessary before you call another station, depending on your signalling system.

[P1] : [DIGITAL]

➔ Push to select the call ID list, transmit message or standby condition. Toggles between queue channel and received message record after queue channel is selected.

➔ Push for 1 sec. to select queue channel indication.

[P4] : [MONI]

Activates one of (or two of) the following functions on each channel independently.

- Push and hold to unmute the channel (audio is emitted; 'audible' condition).
- Push to toggle the mute and unmute conditions (toggles 'audible' and 'inaudible').
- Push to mute the channel (sets to 'inaudible' only).
- Push to unmute the channel (sets to 'audible' only).
- Push after communication is finished to send a 'reset code.'
- Push after communication is finished to send a 'clear down code' during BIIS operation on an MSK channel.

/// **NOTE:** The unmute condition ('audible' condition) may automatically return to the mute condition ('inaudible' condition) after a specified period.

*No function is assigned for [P2] and [P3].

6 POWER SWITCH [⊙]

Push to turn the power ON and OFF.

- The following functions are available at power ON as options:
 - Automatic scan start
 - Password prompt
 - Set mode

7 MICROPHONE CONNECTOR

➔ Connect the supplied microphone or optional DTMF microphone for SmarTrunk II™ operation here.

/// **NEVER** connect non-specified microphones. The pin assignments may be different and the transceiver may be damaged.

MICROPHONE

➔ The supplied microphone has a PTT switch and a hanger hook.

- The following functions are available when the microphone is on or off hook:
 - Automatic scan start when on hook.
 - Automatic priority channel selection when off hook.
 - Sets to 'Inaudible' condition (mute condition) when on hook.
 - Sets to 'Audible' condition (un-mute condition) when off hook.

1 PANEL DESCRIPTION

■ Function display

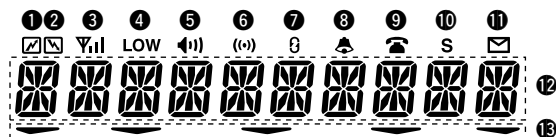

① TRANSMIT INDICATOR

Appears while transmitting.

② RECEIVE INDICATOR

Appears when a signal is received, or the squelch is open.

③ SIGNAL STRENGTH INDICATOR

Shows the relative signal strength while receiving signals.

④ OUTPUT POWER INDICATOR

Appears when Low 2 or Low 1 is selected.

⑤ AUDIBLE INDICATOR

→ Appears when the channel is in the 'audible' (unmute) condition.

→ Appears when the specific 5-tone/BIIS code is received.

⑥ COMPANDER INDICATOR

Appears when the compander function is activated.

⑦ SCRAMBLER INDICATOR

Appears when the voice scrambler function is activated.

• Optional UT-109/110 is required.

⑧ BELL INDICATOR

Appears/blinks when the specific 5-tone/BIIS code is received, according to the programming.

⑨ CALL CODE MEMORY INDICATOR

Appears when the call code memory is selected.

⑩ SCROLL INDICATOR

Appears when a received SDM including more than 10 characters is displayed.

⑪ SDM INDICATOR

Appears when an SDM is received, or a transmit SDM is selected.

⑫ MULTI-FUNCTION INDICATOR

Shows the operating channel number and code simultaneously with the default setting.

The displayed information may differ according to the programming.

⑬ ACTIVATED KEY INDICATOR

Appears above the key assigned as the [DIGITAL] key when that key has been activated.

■ Programmable function keys

The following functions can be assigned to [P0], [P1], [P2], [P3], [P4], [▲], [▼], [^] and [✓] programmable function keys.

Consult your Icom Dealer or System operator for details concerning your transceivers programming.

In the following explanations, programmable function names are bracketed, the specific switch used to activate the function depends on programming.

[CH UP], [CH DN]

CH UP AND DOWN KEYS

- Select an operating channel.
- Select a transmit code channel after pushing the [TX CODE CH] key.
- Select a DTMF channel after pushing the [DTMF] key.
- Select a scan group while pushing and holding the [Scan A/B] key.

[BANK] **BANK KEY**

Select and determine a bank number.

- Push [BANK] then push [CH UP]/[CH DN] to select operating bank number, and then push [BANK] to determine the bank number.

[PRIO A], [PRIO A (Rewrite)], [PRIO B]

PRIORITY CHANNEL KEYS

- ➔ Select Priority A or Priority B channel with each push.
- ➔ Push and hold [PRIO A (Rewrite)] to program the priority channel.

[MR-CH1], [MR-CH2], [MR-CH3], [MR-CH4]

OPERATING CHANNEL KEYS

Select an operating channel directly.

[SCAN A], [SCAN B]

SCAN START/STOP KEYS

- ➔ Push this key to start scanning; and push again to stop.

 **NOTE:** Place the microphone on hook to start scanning.

 Take the microphone off hook to stop scanning.

- ➔ Push and hold this key to indicate the scan group, then push to select the desired group.

[SCAN Add/Del(Tag)]

SCAN TAG KEY

Adds or deletes the selected channel to the scan group.

[High/Low]

OUTPUT POWER SELECTION KEYS

Select the transmit output power temporarily or permanently depending on the pre-setting.

- Ask your Dealer or System Operator for the output power level for each selection.

[TA]

TALK AROUND KEY

Turns the talk around function ON and OFF.

- The talk around function equalises the transmit frequency to the receive frequency for mobile-to-mobile communication.

1 PANEL DESCRIPTION

[MONI (Audi)]

MONITOR KEY

Activates one of (or two of) the following functions on each channel independently:

- Push and hold to un-mute the channel (audio is emitted; 'Audible' condition).
- Push to toggle the mute and un-mute conditions (toggles 'Audible' and 'Inaudible').
- Push to mute the channel (sets to 'Inaudible' only).
- Push to un-mute the channel (sets to 'Audible' only).
- Push after the communication is finished to send a 'reset code'.

 **NOTE:** The un-mute condition ('Audible' condition) may automatically return to the mute condition ('Inaudible' condition) after a specified period.

[TONE] **C. TONE CHANNEL ENTER KEY**

Push this key then input a continuous tone memory channel number using [CH UP]/[CH DN] keys to change the tone frequency.

[PA] **PUBLIC ADDRESS KEY**

When an optional OPC-617 ACC CABLE is installed, the audio output via the cable can be controlled from the transceiver separately from the [VOLUME] control.

- This audio output can be used as a 'public address' function when an external audio amplifier and speaker are connected additionally.
- Push this key, then speak into the microphone while pushing the PTT switch.
- The [CH UP]/[CH DN] keys allow you to set the audio output level from minimum to maximum.

[W/N] **WIDE/NARROW KEY**

Push [W/N] to toggle the IF passband width between wide or narrow.

[RX SP] **EXTERNAL SPEAKER KEY**

When external connections are made for the 'public address' function, the external speaker drive function is also available simultaneously. The received audio can be heard via the external speaker when this key is pushed.

- This function is useful when you are out of the vehicle.
- The audio output level is linked to the transceiver's volume control.

[CALL], [CALL A (Code 30)], [CALL B (Code 29)]

CALL KEYS

Transmit a 5-tone/BIIS code.

- Call transmission is necessary before you call another station depending on your signalling system.
- The [CALL A] and/or [CALL B] keys may be available when your system employs selective 'Individual/Group' calls. Ask your Dealer which call is assigned to each key.

[LOCK] **LOCK KEY**

Electronically locks all programmable keys except the following:

- [CALL] (incl. [CALL A] and [CALL B]), [MONI] and [EMER] keys.

[DTMF Autodial]

DTMF AUTODIAL KEY

Push to select the DTMF channel.

Push [DTMF Autodial] for 1 sec., push [CH UP]/[CH DN] to select the DTMF channel, then push [DTMF Autodial] to transmit the selected DTMF code.

[RE-DIAL]

DTMF RE-DIAL KEY

Push this key to transmit the last-used DTMF code.

[EMER] *EMERGENCY KEY*

- Push and hold to transmit an emergency call.
- When [EMER (Silent)] is pushed, an emergency call is transmitted without a beep emission and LCD indication change.
 - If you want to cancel the emergency call, push (or push and hold) the key again before transmitting the call.
 - The emergency call is transmitted one time only or repeatedly until receiving a control code depending on the pre-setting.

[TX CODE Enter]

TX CODE ENTER KEY

Push to edit the selected MSK channel ID, 5-tone code or BIIS code.

The ID is overwritten when the MSK channel ID “Update” setting is set to “Enable.”

[TX CODE CH Select]

TX CODE CHANNEL SELECT KEY

Selects a 5-tone or BIIS TX code channel.

- Push and hold to change the contents of the TX code using the [CH UP]/[CH DN] keys.
- Push to select a TX code channel using the [CH UP]/[CH DN] keys after pushing this key.
- Push and hold to enter the code.

[TX CODE CH Up], [TX CODE CH Down]

TX CODE CHANNEL UP/DOWN KEYS

Push to select a TX code channel directory.

[ID-MR Select]

ID MEMORY READ KEY

- Recalls detected ID codes.
 - Push this key, then push [CH UP]/[CH DN] for selection.
 - Up to 5 ID's are memorized.
- Push and hold this key to erase all memorized IDs.

[SET]

USER SET MODE KEY

- Changes the contents of the items in the User Set mode.
 - Push and hold [SET] for 1 sec. to enter set mode, push [SET] momentarily to select the item. Push [^] and [v] to set the desired level/condition.
- Push and hold [SET] again to exit set mode.
 - User set mode is also available via the ‘Power ON function.’ Please refer to p. 10 also.

[HOOK SCAN]

HOOK SCAN KEY

When the hook on scan function is turned ON, push this key to stop scanning temporarily. Push this key again to re-start scanning.

[COMP]

MIC COMPANDER KEY

Push to toggle the mic compander function ON or OFF.

1 PANEL DESCRIPTION

[SCRM] **SCRAMBLER KEY**

- Push and hold to turn the voice scrambler function ON.
- Push to turn the voice scrambler function OFF.

NOTE:

- Optional UT-109 (#02) or UT-110 (#02) VOICE SCRAMBLER UNIT is required.
 - UT-109: Non-rolling type. 32 codes are available.
 - UT-110: Rolling type. Provides higher communication security. 1020 (4 groups × 255) codes are available.
- This transceiver requires version #02 unit. Do not install version #01, as it is not compatible.
- UT-109 and UT-110 require some PC board modifications. Please refer to '■ UT-109/110 installation.' (p. 29)
- Please contact your Dealer for details.

[Special Func 1], [Special Func 2] **SPECIAL FUNCTION KEYS** Reserved for future function.

[STATUS UP], [STATUS DN]

- STATUS UP/DOWN KEYS** (BIIS operation only)
- During the standby condition, push to display the transmit status indication and select a status number.
 - When a received SDM is displayed, push to cancel the automatic scroll and scroll the message manually.
 - When an SDM that contains more than 10 characters is displayed, push to scroll the message manually.

[OPT OUT]

OPTION KEYS

Control the output signal level of the optional ports in the optional unit connector.

[DIGITAL]

DIGITAL FUNCTION KEY (BIIS operation only)

- Push to select the call ID list, transmit message or standby condition. Toggles between queue channel and received message record indication after queue channel is selected.
- Push for 1 sec. to select queue channel indication.

[GRP] **TRUNKING GROUP KEY**

Push to select the Trunking group.

[TURBO] **TURBO Speedial A/B/C/D KEYS**

During SmarTrunk II™ operation, when a key is assigned this function, push it to automatically dial a commonly used number with one push.

[* (CH UP)], [# (CH DN)]

CALL/CLEAR-DOWN KEYS

Functions as [*] and [#] keys on the DTMF microphone for SmarTrunk II™ operation.

- Push [*] for call, push [#] for clear-down.

[ID SW] **TRUNKING CALLER ID SW KEY**

Push to display the received ID record in sequence (while in SmarTrunk 3G™ operation).

■ Turning power ON

- ① Push [⏻] to turn the power ON.
 - A power-up alert tone sounds for about 1 sec. and an opening message may appear.
- ② If the transceiver is programmed for a start up passcode, input digit codes as directed by your Dealer.
 - The keys in the table below can be used for password input:
 - The transceiver detects numbers in the same block as identical. Therefore “01234” and “56789” are the same.

KEY	[P0]	[P1]	[P2]	[P3]	[P4]
NUMBER	0 5	1 6	2 7	3 8	4 9

- ③ When the “PASSWORD” indication does not clear after inputting 4 digits, the input code number may be incorrect. Turn power off and start over in this case.

■ Channel selection

Several types of channel selections are available. Methods may differ according to your system set up.

NON-BANK TYPE:

Push [CH UP]/[CH DN] to select the desired operating channel, in sequence; or, push one of the [CH 1] to [CH 4] to select a channel directly.

BANK-TYPE:

Push [BANK] to select the desired bank number.

AUTOMATIC SCAN TYPE:

Channel setting is not necessary for this type. When turning the power ON, the transceiver automatically starts scanning. Scanning stops when receiving a call or when taking the microphone off hook.

■ Receiving and transmitting

RECEIVING:

- ① Push [⏻] to turn the power ON.
- ② Push [CH UP] or [CH DN] to select a channel.
- ③ When receiving a call, adjust the audio output level to a comfortable listening level.

TRANSMITTING:

- ④ Take the microphone off hook.
 - 5-tone mute may be released (the 'audible' condition is selected and "🔊" appears).
 - A priority channel may be selected automatically.
- ⑤ Wait for the channel to become clear.
 - The channel is busy when "🔊" appears.
- ⑥ Push the [CALL] key when initiating a call from your side.
 - Coded audio may be heard (except for MSK call) from the transceiver, then "🔊" appears.
 - This operation may not be necessary depending on your signaling system. Ask your Dealer.
- ⑦ While pushing and holding [PTT], speak into the microphone at your normal voice level.
- ⑧ Release [PTT] to receive.

-  **IMPORTANT:** To maximize the readability of your signal:
- (1) Pause briefly after pushing [PTT]
 - (2) Hold the microphone 2.5 to 5 cm from your mouth, then speak into the microphone at a normal voice level.

◇ Transmitting notes

• Transmit inhibit function

The transceiver has several inhibit functions which restrict transmission under the following conditions:

- The channel is in mute condition ('Inaudible' condition; "🔊") does not appear).
- Channel is busy.
- No matched (or matched) CTCSS/DTCS is received.
- The selected channel is a 'receive only' channel.

• Time-out timer

After continuous transmission for a pre-programmed period, the time-out timer is activated causing the transceiver to stop transmitting and automatically select receive.

• Penalty timer

Once the time-out timer is activated, transmission is further inhibited for a period determined by the penalty timer.

◇ Tx code number selection

If the transceiver has a [CODE] key, Tx code contents can be changed within the allowable digits.

TO SELECT A TX CODE:

- ① Push [TX CODE ENT]— a Tx code number appears and the first digit blinks.
- ② Push [CH UP]/[CH DN] to select the desired number of the blinking digit.
- ③ Push [TX CODE ENT] to enter the selected number and the next digit will start blinking automatically.
- ④ Repeat steps ② and ③ to input all allowed digits.
- ⑤ Push [CALL] to transmit the selected TX code.

◇ Tx code channel selection

If the transceiver has a [TX CODE CH UP] or [TX CODE CH DN] key, the programmed Tx code channel can be selected directly.

◇ DTMF transmission

If the transceiver has a [DTMF] key, the automatic DTMF transmission function is available. Up to 7 DTMF channels are available.

- ① Push [DTMF]— a DTMF code channel appears.
- ② Push [CH UP]/[CH DN] to select the desired DTMF channel.
- ③ Push [DTMF] to transmit the selected DTMF.

◇ Scrambler function

UT-109 (#02) or UT-110 (#02) optional voice scrambler unit provides high performance private communication between stations with the same scrambler codes.

- ① Push and hold [SCRM] to turn the scrambler function ON.
- ② “” appears.
- ③ Push [SCRM] to turn the function OFF.

◇ User set mode

User set mode is accessed at power ON and allows you to set seldom-changed settings. In this case you can “customize” transceiver operation to suit your preferences and operating style.

Entering the user set mode:

- ① While pushing and holding [^] and [v], push [D] to enter the user set mode at power ON.
- ② Push and hold [P0] to enter user set mode. Push [P0] momentarily to select the item.
Then push [^] and [v] to set the desired level/condition.

Available set mode functions:

- Backlight : AUTO, DIM, OFF or ON
- Beep : ON or OFF
- Beep Level : 1 to 5 or Link (links to audio output level)
- SQL Level : 0 to 255
- AF Min level : 0 to 255
- Audio Filter : 3000, 3400, 0 or 300
- Mic Gain : 1 to 5
- Horn : ON or OFF

- ③ Push [D] (or push and hold [P0]) again to exit set mode.

User set mode is also available via a programmable key. Please refer p. 6 [SET] section.

■ Default setting

The following functions are assigned to each programmable switch as the default. Ask your dealer for details.

- [P0]; CALL : Push to send a 5-tone call or BIIS call when the selected channel is a 5-tone or MSK channel, respectively.
- [P1]; DIGITAL : Push to select the call list ID/transmit message, or to display the receive message record for selection.
- [P2], [P3]; Null : No function is assigned.
- [P4]; MONI : Pushing this switch after the communication to send a “clear down” signal during MSK channel operation.
- [▲]/[▼]; Status Up/Down : Selects status indication and a status message or SDM channel.
When an SDM is received, cancels the auto scroll and scrolls the message manually.
When a transmit SDM is selected, edit the SDM.
- [^]/[v]; CH Up/Down : During standby condition, selects the operating channel.
After pushing [DIGITAL] or [TX Code], selects call list or TX code memory channel, respectively.

■ Receiving a call

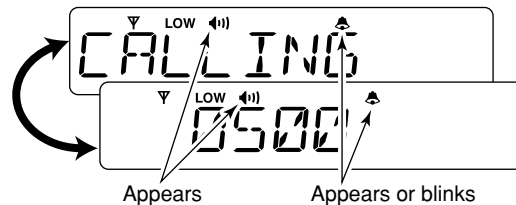

◇ Individual call

- When an individual call is received;
 - Beeps sound.
 - “◀||)” appears and the mute is released.
 - The programmed text message (e.g. “CALLING”) and the calling station ID (or text) is displayed alternately.
 - “▲” appears or blinks depending on the setting.



- Push and hold [PTT] (microphone), then speak into the microphone at a normal voice level.
 - “” appears during transmit.
- Release [PTT] to return to receive.
 - “” appears while receiving the signal.
- To finish the conversation, push [MONI (P4)] to send the “Clear down” signal.
 - Either station can send.
 - “CLEAR DOWN” is displayed for 2 sec. (approx.).
 - “◀||)” disappears and the transceiver returns to standby condition.

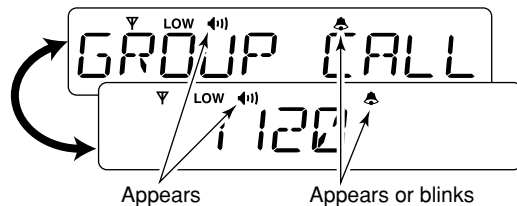

◇ Group call

- When a group call is received;
 - Beeps sound.
 - “” appears and the mute is released.
 - The programmed text message (e.g. “GROUP CALL”) and the calling station ID (or text) is displayed alternately.
 - “” appears or blinks depending on the setting.



- Push and hold [PTT] (microphone), then speak into the microphone at a normal voice level.

⚡ **NOTE:** Only one station is permitted.

 - “” appears during transmit.
- Release [PTT] to return to receive.
 - “” appears while receiving a signal.
- To finish the conversation, push [MONI (P4)] to send the “Clear down” signal.
 - Either station can send.
 - “CLEAR DOWN” is displayed for 2 sec. (approx.).
 - “” disappears and the transceiver return to standby condition.

◇ Displaying the received call record — Queue indication

The transceiver memorizes the calling station IDs for record. Up to 3 calls can be memorized, and the oldest call record is erased when a 4th call is received. However, once the transceiver is powered OFF, all records are cleared.

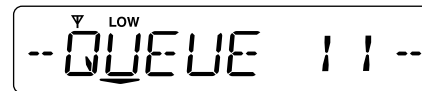

- Push [DIGITAL (P1)] for 1 sec.
 - Displays following indication.

• When a record is available



• When no record is available



- Push []/[] to select the desired call.
- Push [DIGITAL (P1)] for 1 sec. again to return to standby condition.
 - When no operation is performed for 30 sec., the transceiver returns to standby condition automatically.

3 BIIS OPERATION

■ Transmitting a call

A total of 3 ways for code selection are available— selecting the call code from memory, entering the call code from the keypad and calling back from the queue channel record.

◇ Using call memory

- ① During standby condition, push [DIGITAL (P1)] to select call code memory channel.
 - “☎” appears.

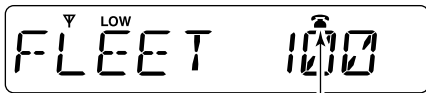

Appears

- ② Push [^]/[v] to select the desired call code.
- ③ Push [CALL (P0)] or [PTT]* to call.
 - *PTT call can be made only when PTT call capability is permitted.
 - /// **NOTE:** When no answer back is received, the transceiver repeats the call 3 times (default) automatically, and “WRIT” is displayed during each call. However, an error beep sounds and “FRILE” is displayed when no answer back is received after the calls.
- ④ Push [PTT] to transmit; release to receive.
- ⑤ Push [MONI (P4)] to clear down.

◇ Calling back from the queue channel

- ① During standby condition, push [DIGITAL (P1)] for 1 sec. to select queue memory.
- ② Push [^]/[v] to select the desired record.

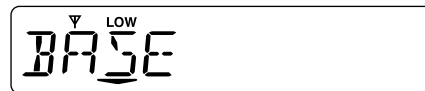

Queue memory content is displayed.

- ③ Push [CALL (P0)] or [PTT]* to call.
 - *PTT call can be made only when PTT call capability is permitted.
 - /// **NOTE:** When no answer back is received, the transceiver repeats the call 3 times (default) automatically, and “WRIT” is displayed during each call. However, an error beep sounds and “FRILE” is displayed when no answer back is received after the calls.
- ④ Push [PTT] to transmit; release to receive.
- ⑤ Push [MONI (P4)] to clear down.

◆ Direct code entry

- ① During standby condition, push [TX CODE ENT] to select call code entering condition.



Queue memory content is displayed.

- ② Select the desired code number via [^]/[v] then push [TX CODE ENT].
- Programmable digit number differs according to the setting.
 - When the optional DTMF microphone is used, push the appropriate digit key, [0] to [9], to set the desired code.
- ③ Repeat step ② until the desired code is set.
- After the code is entered, the digit stops blinking.
- ④ Push [CALL (P0)] or [PTT]* to call.
- *PTT call can be made only when PTT call capability is permitted.

/// **NOTE:** When no answer back is received, the transceiver repeats the call 3 times (default) automatically, and “*WAIT*” is displayed during each call. However, an error beep sounds and “*FAILED*” is displayed when no answer back is received after the calls.

- ⑤ Push [PTT] to transmit; release to receive.
- ⑥ Push [MONI (P4)] to clear down.

For your information

When the “Update” setting for the call code is enabled, the set code is overwritten into the call code memory.

3 BIIS OPERATION

■ Receiving a message

◇ Receiving a status message

- ① When a status message is received;
 - Beeps sound.
 - The calling station ID (or text) and the status message is displayed alternately.

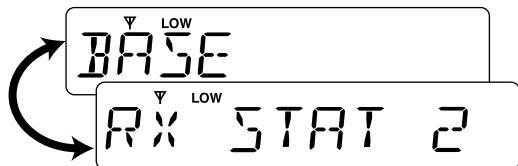

- ② Push [MONI (P4)] to return to standby condition.

NOTE: Only the calling station ID (or text) is displayed (no message is displayed alternately) when the scroll timer is set to "OFF." In this case, push [▼] to display the status message.

◇ Receiving an SDM

- ① When a status message is received;
 - Beeps sound.
 - "✉" appears.
 - The calling station ID (or text) and the SDM is displayed alternately.

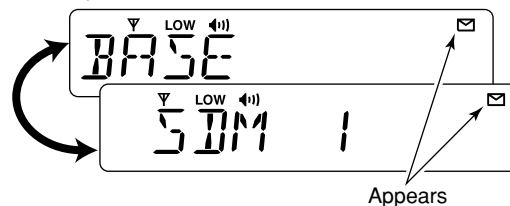

- ② When the received SDM includes more than 10 characters, "S" is displayed and scrolls the message automatically.
 - Push [▲]/[▼] to scroll the message manually.
- ③ Push [MONI (P4)] to return to standby condition.

◇ Received message selection

The transceiver memorizes the received messages for record. Up to 6 messages for status and SDM, or 192 character SDM's can be memorized, and the oldest message is erased when the 7th message is received. However, once the transceiver is powered OFF, the all messages are cleared.

- ① Push [DIGITAL (P1)] for 1 sec.
 - Displays queue memory.
- ② Push [DIGITAL (P1)] momentarily.
 - Displays message memory.

- **When a message is available**

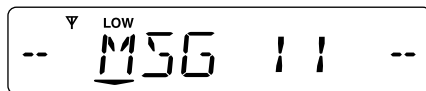

- **When no message is available**

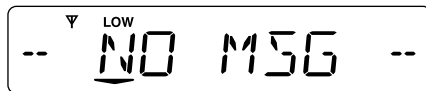

- ③ Push [^]/[v] to select the desired message.
 - When selecting the SDM that includes more than 10 characters, "S" is displayed. Push [▲]/[▼] to scroll the message manually.
- ④ Push [DIGITAL (P1)] for 1 sec. again to return to standby condition.
 - When no operation is performed for 30 sec., the transceiver returns to the standby condition automatically.

For your information

When using the optional DTMF microphone, [*] and [#] keys on the microphone function as [▲] and [▼] on the front panel, respectively.

■ Transmitting a status

◇ General

The status message can be selected with the programmed text, and the message text is also displayed on the function display of the called station.

Up to 24 status types (1 to 24) are available, and the status message 19, 22, 23 and 24 have designated meanings.

Status 19: Power OFF*

Status 22: Emergency

Status 23: Power ON*

Status 24: GPS request

*The status 19 and 23 can also be used as normal status messages by disabling the designated meaning. However, status 22 and 24 are fixed.

The status call can be sent with both individual and group calls.

◇ Select a status from status memory

① During standby condition, push [DIGITAL (P1)], then push [^]/[v] to select the desired station/group code.

② Push [DIGITAL (P1)] again, then push [^]/[v] to select the desired status message.

Or, push [▲] or [▼] to select the desired status message.

• When the optional DTMF microphone is used, pushing [*]/[#] returns the transceiver to standby condition.

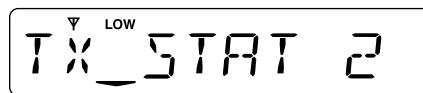

Status message is displayed.

③ Push [CALL (P0)] or [PTT]* to transmit the status message to the selected station/group.

*PTT call can be made only when PTT call capability is permitted.
• 2 beeps will sound and the transceiver returns to the standby condition automatically when the transmission is successful.

For your information

When the optional DTMF microphone is used, pushing [1]–[9] selects the status message 1–9, and pushing [0] selects the status message 10, respectively, even during standby condition.

■ Transmitting an SDM

◇ General

A short data message, SDM, can be input directly (max. 10 characters), and sent to an individual station or group stations. Also, 8 SDM memory channels are available and the messages can be edited via the optional DTMF microphone's keypad or PC programming.

◇ Transmitting an SDM

- ① During standby condition, push [DIGITAL (P1)], then push [^]/[v] to select the desired station/group code.
- ② Push [DIGITAL (P1)] again, then push [^]/[v] to select the desired SDM.

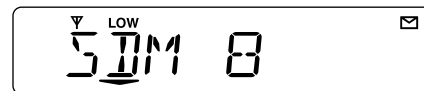

SDM is displayed.

- ③ Push [CALL (P0)] or [PTT]* to transmit the SDM to the selected station/group.
 - *PTT call can be made only when PTT call capability is permitted.
 - 2 beeps will sound and the transceiver returns to the standby condition automatically when the transmission is successful.

3 BIIS OPERATION

◆ Programming an SDM memory

(optional DTMF microphone is required)

- ① During standby condition, push [DIGITAL (P1)] twice, then push [^]/[v] to select the desired SDM to be edited.
- ② Push [*] or [#] to enter the message editing condition.
 - The first character blinks when [#] is pushed, the last character blinks when [*] is pushed as below.

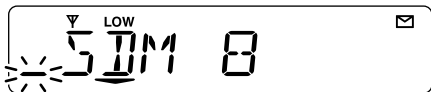

- ③ Push the appropriate digit key, [0] to [9], to enter the desired character.
 - See the table at right for the available characters.
 - Pushing [^] also enters space, pushing [v] deletes the selected character.
- ④ Push [*] to move the cursor to the right, push [#] to move the cursor to the left.
- ⑤ Repeat steps ③ and ④ to set the desired text message.
- ⑥ Push [DIGITAL (P1)] for 1 sec. to overwrite the set content into the memory.
 - Push [DIGITAL (P1)] momentarily to cancel the editing and return to the original message indication.

• Available characters

Key	Characters
[0]	0 (0) , (.) ! (!) ? (?) ' (') " (") , (,) ; (;) : (:) _ () : (() : ()) < (<) > (>) [([] (]
[1]	1 (1) (Space) # (#) * (*) / (/) + (+) - (-) = (=) \ (\) & (&) % (%) \$ (\$) @ (@) ^ (^)
[2]	2 (2) A (A) B (B) C (C) a (a) b (b) c (c)
[3]	3 (3) D (D) E (E) F (F) d (d) e (e) f (f)
[4]	4 (4) G (G) H (H) I (I) g (g) h (h) i (i)
[5]	5 (5) J (J) K (K) L (L) j (j) k (k) l (l)
[6]	6 (6) M (M) N (N) O (O) m (m) n (n) o (o)
[7]	7 (7) P (P) Q (Q) R (R) S (S) p (p) q (q) r (r) s (s)
[8]	8 (8) T (T) U (U) V (V) t (t) u (u) v (v)
[9]	9 (9) W (W) X (X) Y (Y) Z (Z) w (w) x (x) y (y) z (z)

■ Position data transmission

When the optional OPC-822 INTERFACE CABLE and a GPS receiver is connected to the transceiver, the position (longitude and latitude) data can be transmitted automatically.

Ask your dealer or system operator for connection details.

The position data is transmitted when;

- Status 24 message is received
 - *When the status 24 message, GPS request, is received.
- Fully automatic
 - When automatic position transmission is enabled, send the position data according to 'Time Marker' and 'Interval' settings.
- PTT is released
 - When 'Send At Log-off' is enabled.
- After sending a status message
 - When 'Send With Status' is enabled.
- After sending an SDM
 - When 'Send With SDM' is enabled.
- After sending status 22 (Emergency)
 - When 'Send With Emergency' is enabled.

■ Printer connection

When the optional OPC-822 INTERFACE CABLE is connected to the transceiver, a printer can be connected to printed out the received SDM content and the ID of the station who sent the message. Ask your dealer or system operator for connection details.

■ PC connection

When the optional OPC-822 INTERFACE CABLE is connected to the transceiver, a PC can be connected to provide remote control, data reception, etc.

Ask your dealer or system operator for connection details.

■ Digital ANI

The own ID can be transmitted each time the PTT is pushed (log-in) or released (log-off) during individual or group call communications.

By receiving the ANI, the communication log can be recorded when using a PC dispatch application.

In addition, when using the ANI with log-in, the PTT side tone function can be used to inform you that the ID is sent and voice communication can be performed.

3 BIIS OPERATION

■ Auto emergency transmission

When [EMER (Silent)] is pushed, an emergency signal is automatically transmitted for the specified time period.

The status 22 (Emergency) is sent to the selected ID station, and the position data is transmitted after the emergency signal when a GPS receiver is connected to the transceiver.

The emergency transmission is performed on the emergency channel, however, when no emergency channel is specified, the signal is transmitted on the previously selected channel.

There is no change in the function display or beep emission during automatic emergency transmission.

■ Stun function

When the specified ID, set as a killer ID, is received, the stun function is activated.

When the killer ID is received, the transceiver switches to the passcode required condition. Entering of the passcode via the keypad is necessary to operate the transceiver again in this case.

■ BIIS indication

The following indications are available for the BIIS operation on an MSK channel.

<i>CONNECT</i>	: Individual/group call is successful.
<i>OK</i>	: Message (status or SDM) transmission is successful.
<i>FAILED</i>	: No answer back is received.
<i>WAIT</i>	: Appears during retry of the call (2nd call).
<i>CLEAR DOWN</i>	: The call is cancelled for some reason.
<i>BUSY</i>	: Called station is in busy.

■ Horn output

An automatic horn sounding function is available when the optional OPC-617 ACC CABLE is connected. When a status message is received, the transceiver controls the vehicles horn for the specified time period to inform you that a status message is received.

This function is convenient when the operator away from the transceiver or vehicle.

Ask your dealer or system operator for connection and setting details.

■ Priority A channel selection

When one of the following operations is performed, the transceiver selects the Priority A channel automatically.

Priority A is selected when;

- Clear down signal is received/transmitted
 - Set the “Move to PrioA CH” item as “Clear Down.”
- Turning the power ON
 - The Priority A channel is selected each time the transceiver power is turned ON.
- Status call
 - The Priority A channel is selected when transmitting a status call.
 - Enable the “Send Status on PrioA CH” item in the MSK configuration.

■ SmarTrunk II™ and conventional modes

This transceiver is capable of SmarTrunk II™ functions.

The optional UT-105 allows communication in conventional channels or SmarTrunk II™ channels. Select a channel bank for SmarTrunk II™ before trunking operation.

- Push [BANK] then push [CH UP]/[CH DN] to select a channel bank for conventional channels or SmarTrunk II™ channels, and then push [BANK].
 - Scanning starts when a channel bank for SmarTrunk II™ operation is selected.
 - Contact your Dealer for channel bank details.

 **NOTE:** The optional DTMF microphone is required. Contact your Dealer for details.

■ SmarTrunk II™ operation

These features are enabled by a Dealer and may not be available in your system. Contact your Dealer for details.

◇ Placing a telephone call

Enter the phone number followed by [1], [*].

- A high-pitched beep indicates that the number is accepted.
- When the called party answers, push the [PTT] switch to talk, and release it to listen.

◇ Calling another local system subscriber

Enter the subscriber number followed by [3], [*].

- A high-pitched beep indicates that the number is accepted.
- You hear ringing, then two short beeps when the subscriber answers.
- If the other subscriber is on another call or out of range, you hear a fast busy signal and the call terminates automatically.

◇ Receiving a call

When you hear ringing, push [*] to answer.

- For a group call, you hear a short ring followed by two short beeps. You do not have to answer a group call to hear it over the air.

◇ Terminating a call

After completing a call, push [#] to disconnect (hang up).

/// **IMPORTANT:** If one person in the conversation terminates a call, all participants will be cut off.

◇ Last number re-dial

Push [*] 2 times to automatically re-dial the last called number.

- A high-pitched beep indicates that the number is accepted.

◇ Memory speed-dialling

To automatically dial a commonly used number from memory:

- Push [*] followed by the memory location (0–9).

◇ Turbo Speedial

To automatically dial a commonly used number with one push:

- Push one of the turbo Speedial keys ([A], [B], [C] or [D]).

◇ Programming memory speed dial

- ① Push and hold [*] until you hear a high-pitched beep.
- ② Enter the memory location (0–9, A, B, C, D), the telephone or subscriber number, then [1], [*] (or [3], [*] if for another system subscriber).
 - A high-pitched beep indicates successful programming.
 - Memories [A]–[D] are used for the Turbo Speedial.

◇ System busy indication

If all channels are busy, three low beeps sound after you initiate a call. Try the call again later.

◇ PTT dispatch operation

- ① Push [PTT] once (without dialling) to initiate a dispatch call.
- ② Begin talking after you hear three beeps (one short, high-pitched, two very-short, low-pitched).
- ③ Receiving a dispatch call is indicated by the same three-beep sequence.
 - It is not necessary to push [*] to answer a dispatch call.

◇ Emergency call

Push [0], [*] to initiate an emergency call.

- Contact your dealer for details.

◇ Clear channel alerting

If all channels are busy, the transceiver automatically begins searching for an open channel and beeps every ten seconds. When two short beeps (low-pitched, then high-pitched) are heard, a channel is available. Push [*], [*] immediately to re-dial the last number.

/// **NOTE:** For additional operating instructions, contact your Dealer or System Operator.

5

CONNECTION AND INSTALLATION

■ Rear panel description and connections

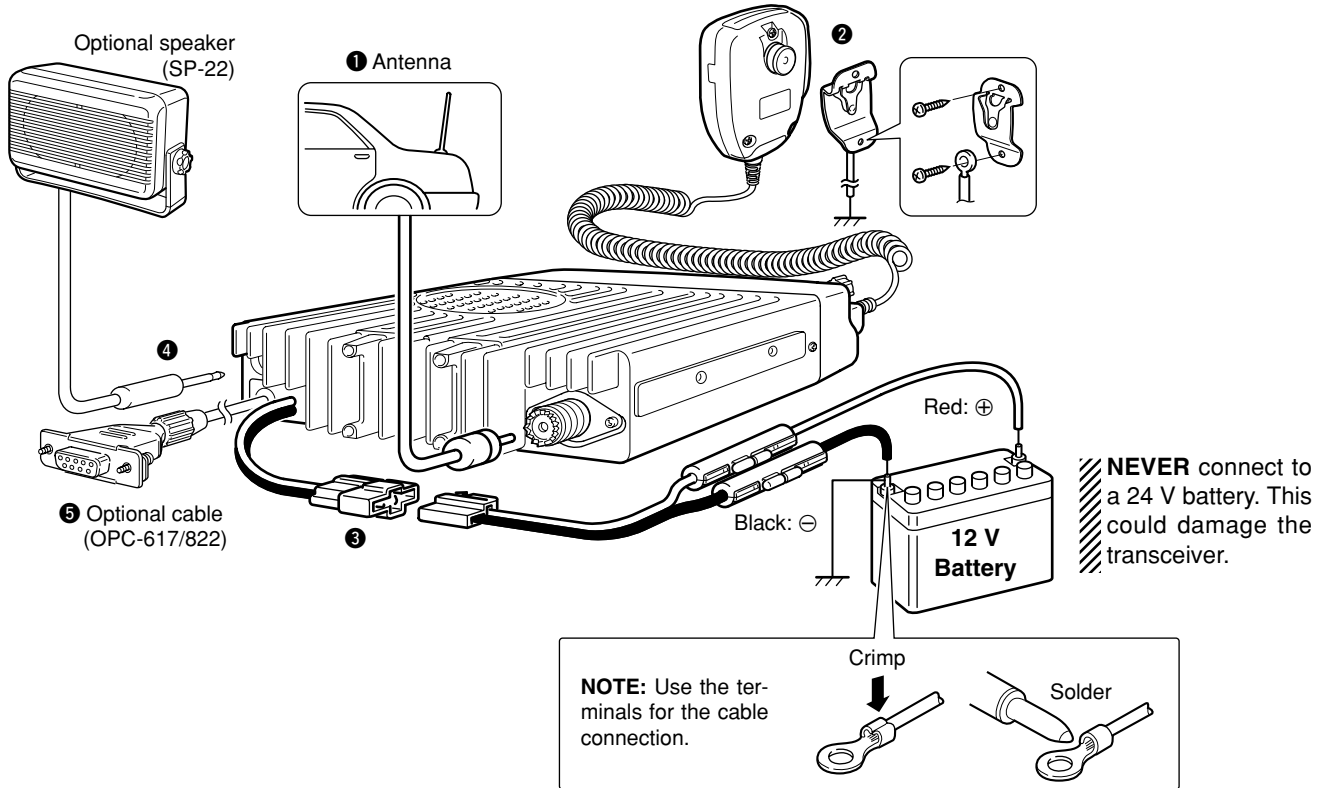

1 ANTENNA CONNECTOR

Connects to an antenna. Ask your dealer about antenna selection and optimal antenna locations.

2 MICROPHONE HANGER

Connects the supplied microphone hanger to the vehicle's ground for the hanger function.

3 DC POWER RECEPTACLE

Connects to a 12 V DC battery. Pay attention to polarities. **NEVER** connect to a 24 V battery. This could damage the transceiver.

4 EXTERNAL SPEAKER JACK

Connects an optional external speaker.

5 OPTIONAL CABLE (OPC-617 or OPC-822)

Connects an external modem unit, GPS receiver, printer, PC, LCD backlight control, audio amplifier for the 'public address' function, etc., according to the installed cable type.

Supplied accessories

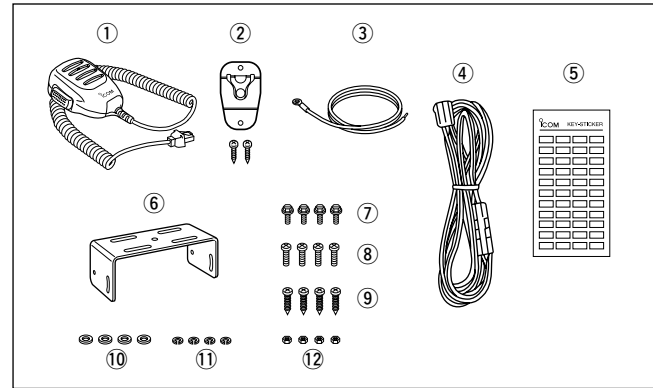

- 1 Microphone1
- 2 Microphone hanger and screw set1 set
- 3 Microphone hanger cable ... 1
- 4 DC power cable (OPC-1132)1
- 5 Function name stickers (KEY STICKERS)1
- 6 Mounting bracket1
- 7 Mounting bolts4
- 8 Mounting screws (M5×12) 4
- 9 Self-tapping screws (M5×20)4
- 10 Flat washers4
- 11 Spring washers4
- 12 Nuts4

◇ Function name stickers

Use these to label the programmable function keys ([P0] to [P4]) according to their assigned functions.

5 CONNECTION AND INSTALLATION

■ Mounting the transceiver

The front panel can be inverted for correct viewing while leaving the built-in speaker facing away from the mounting surface.

◇ Inverting the Front panel

- ① Unscrew the 2-side screws.
- ② Detach the Front panel forward from the transceiver.
- ③ Bend the flat cable between the Front panel and main unit as shown in the following diagram.

- ④ Invert the transceiver 180 degrees clockwise as below.
- ⑤ Re-attach the Front panel to the transceiver.
- ⑥ Tighten the 2 screws.

CAUTION:

- NEVER rotate the transceiver more than 180 degrees.
- DO NOT bend the flat cable too much. Damage may occur.

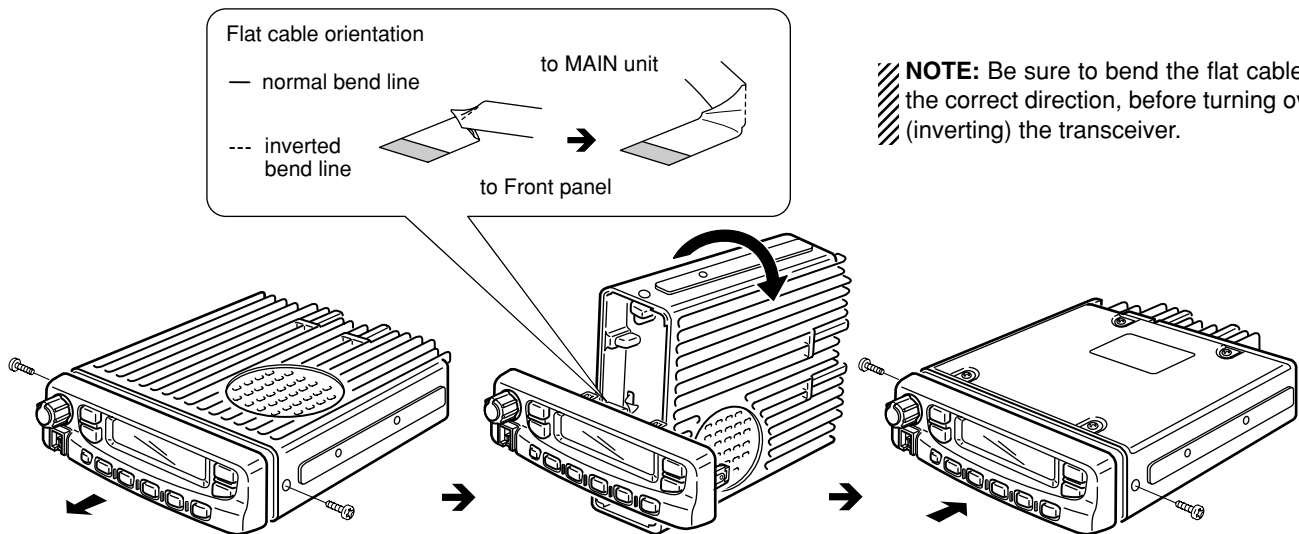

◇ Mounting the transceiver

The universal mounting bracket supplied with your transceiver allows overhead mounting.

- Mount the transceiver securely with the 4 supplied screws to a thick surface which can support more than 1.5 kg.

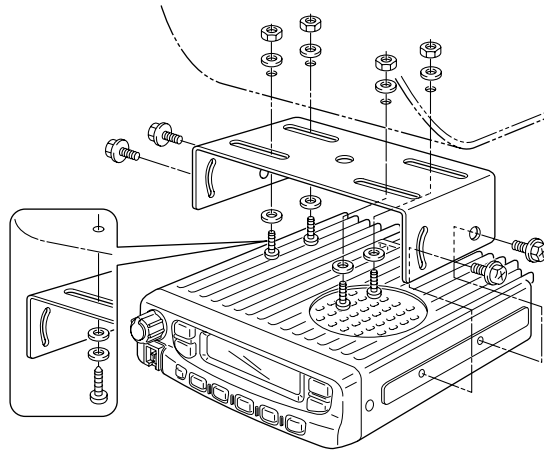

■ Optional unit installation

◇ UT-105/UT-117 installation

Install the optional unit UT-105 or UT-117, provides SmarTrunk II™ or SmarTrunk 3G™ function, as below.

- ① Turn power off, then disconnect the DC power cable.
- ② Unscrew the 4 screws, then remove the bottom cover.
- ③ Install the unit as shown in the diagram below.

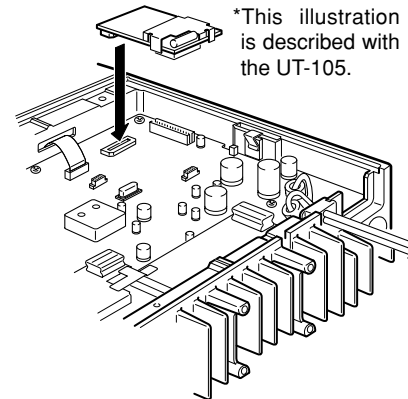

- ④ Attach the bottom cover and screws to their original position, then connect the DC power cable.

5 CONNECTION AND INSTALLATION

◆ UT-109/UT-110/UT-117S installation

Install the optional unit as below.

- ① Turn power off, then disconnect the DC power cable.
- ② Unscrew the 4 screws, then remove the bottom cover.
- ③ Cut the print patterns on the PCB at the transmit mic circuit (MIC) and receive AF circuit (AFO) as shown in the diagram below.
- ④ Install the unit as described in page 28.
- ⑤ Attach the bottom cover and screws to their original position, then connect the DC power cable.

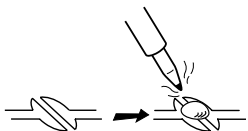
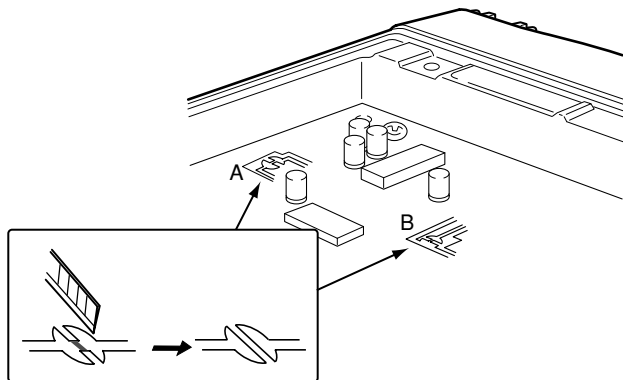

NOTE: Be sure to re-solder above print patterns, when you remove the scrambler unit. Otherwise no TX modulation or AF output is available.

◆ OPC-617/822 installation

Either the optional OPC-617 ACC CABLE or OPC-822 INTERFACE CABLE can be installed.

Install the OPC-617 or OPC-822 as shown bellow.

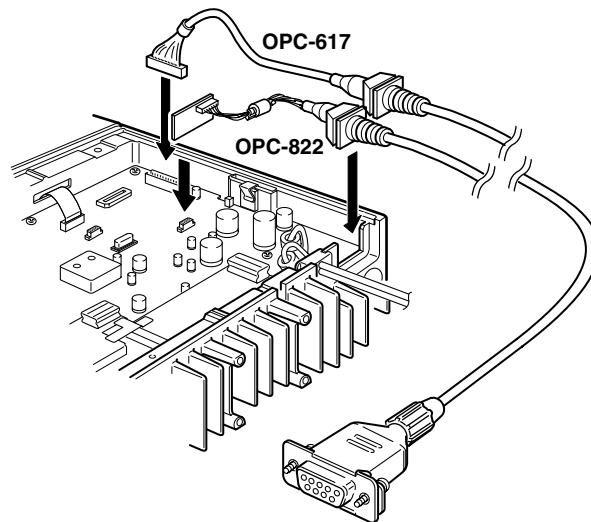

• Connector information

OPC-617 Pin Assignment

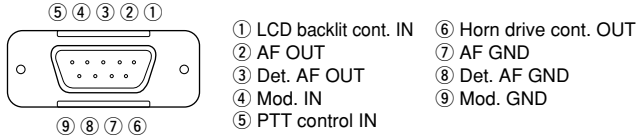

OPC-822 Pin Assignment

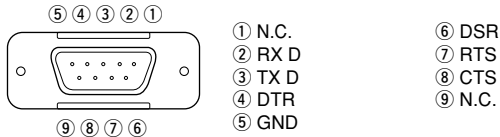

■ Antenna

A key element in the performance of any communication system is an antenna. Ask your Dealer about antennas and the best places to mount them.

■ Fuse replacement

A fuse is installed in the supplied DC power cable. If a fuse blows or the transceiver stops functioning, track down the source of the problem, if possible, and replace the damaged fuse with a new rated one.

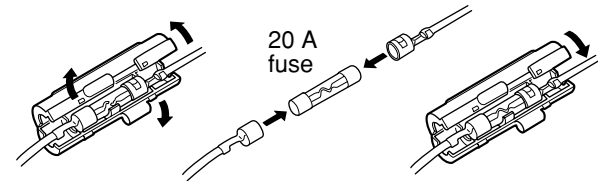

■ Cleaning

If the transceiver becomes dusty or dirty, wipe it clean with a soft, dry cloth.



AVOID the use of solvents such as benzene or alcohol, as they may damage the transceiver surfaces.

6

OPTIONS

UT-105 SmarTrunk II™ LOGIC BOARD

For SmarTrunk II™ operation.

UT-117/UT-117S* SmarTrunk 3G™ LOGIC BOARD

For SmarTrunk 3G™ operation.

*In addition to SmarTrunk 3G™ capabilities, UT-117S supports the voice scrambler capability.

/// **NOTE:** The optional CS-F500 CLONING SOFTWARE Rev. 2.1 or later is required.

UT-108 DTMF DECODER UNIT

Provides pager and code squelch capabilities.

UT-109/UT-110 VOICE SCRAMBLER UNITS

- UT-109: Non-rolling type (max. 32 codes)
- UT-110: Rolling type (max. 1020 codes)

UT-111 TRUNKING BOARD

Provides LTR® trunking capabilities.

SP-22 EXTERNAL SPEAKER



Compact and easy-to-install. Same as that supplied with some versions.

Input impedance: 4 Ω
Max. input power: 5 W

HM-152/HM-152T/HM-148 HAND MICROPHONE

- HM-152 : Hand microphone. The same as that supplied with the transceiver.
- HM-152T : DTMF microphone
- HM-148 : Heavy duty microphone

SM-25 DESKTOP MICROPHONE

For base station operation.
Monitor switch is equipped.



OPC-617 ACC CABLE

Provides external terminal connection.



OPC-822 INTERFACE CABLE

Provides advanced operation, such as printer, GPS connection for position data transmission capabilities.

Some options may not available is some countries. Please ask your dealer for details.

SmarTrunk II™ and SmarTrunk 3G™ are Trademark of SmarTrunk Systems, Inc.
LTR is a registered trademark of EF Johnson Radio Systems.



Your Icom radio generates RF electromagnetic energy during transmit mode. This radio is designed for and classified as “Occupational Use Only”, meaning it must be used only during the course of employment by individuals aware of the hazards, and the ways to minimize such hazards. This radio is **NOT** intended for use by the “General Population” in an uncontrolled environment.

- For compliance with FCC and Industry Canada RF Exposure Requirements, the transmitter antenna installation shall comply with the following two conditions:
 1. The transmitter antenna gain shall not exceed 0 dBi.
 2. **IC-F521:**

The transmitter antenna is required to be located outside of a vehicle and kept at a separation distance of 63 centimeters or more between the transmitter antenna of this device and persons during operation.
 3. **IC-F621:**

The transmitter antenna is required to be located outside of a vehicle and kept at a separation distance of 50 centimeters or more between the transmitter antenna of this device and persons during operation.



To ensure that your exposure to RF electromagnetic energy is within the FCC allowable limits for occupational use, always adhere to the following guidelines:

- **DO NOT** operate the radio without a proper antenna attached, as this may damage the radio and may also cause you to exceed FCC RF exposure limits. A proper antenna is the antenna supplied with this radio by the manufacturer or an antenna specifically authorized by the manufacturer for use with this radio.
- **DO NOT** transmit for more than 50% of total radio use time (“50% duty cycle”). Transmitting more than 50% of the time can cause FCC RF exposure compliance requirements to be exceeded. The radio is transmitting when the “TX indicator” lights red. You can cause the radio to transmit by pressing the “PTT” switch.

Electromagnetic Interference/Compatibility

During transmissions, your Icom radio generates RF energy that can possibly cause interference with other devices or systems. To avoid such interference, turn off the radio in areas where signs are posted to do so. **DO NOT** operate the transmitter in areas that are sensitive to electromagnetic radiation such as hospitals, aircraft, and blasting sites.

Count on us!

A-6252D-1EX-②
Printed in Japan
© 2003–2005 Icom Inc.

Icom Inc.
1-1-32 Kamiminami, Hirano-ku, Osaka 547-0003, Japan